

Amern®

RIVAL SERIES



AN-SLZ

All in one solar street light

CE (RoHS) P66 IK10

INTRODUCTION

01 PART ONE
PRODUCT ADVANTAGE

02 PART TWO
SPECIFICATIONS

03 PART THREE
EXPLODED VIEW

04 PART FOUR
PRODUCT DETAIL

05 PART FIVE
OPTICAL FEATURE

06 PART SIX
DIMENSION FIGURE

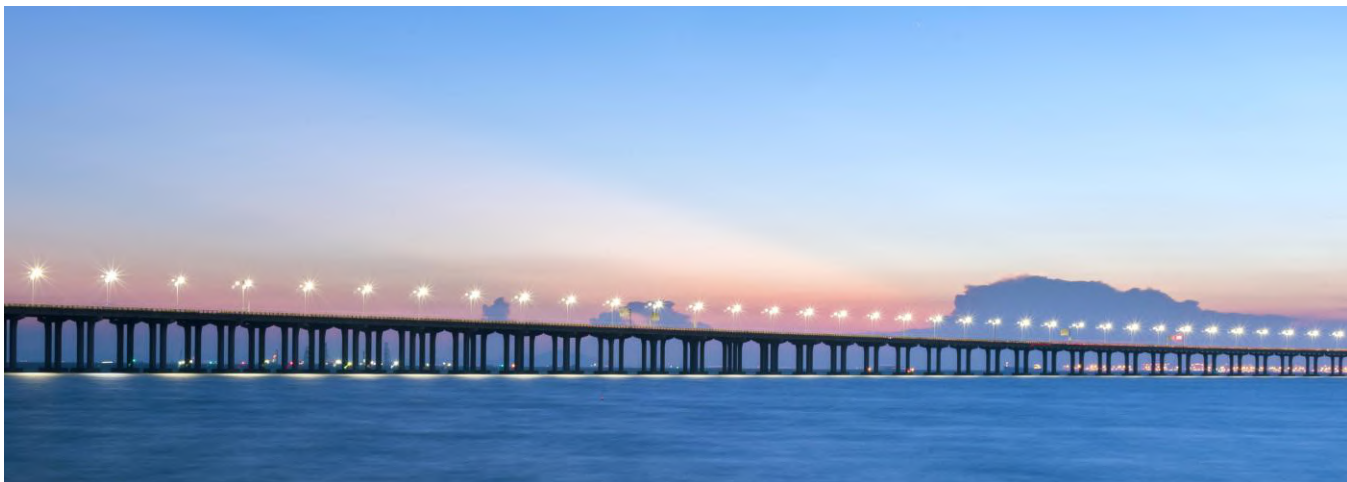

01 PART ONE PRODUCT ADVANTAGE



Product Advantage

MAINSTREAM INTEGRATED STRUCTURE DESIGN

Saving transportation cost.
Easy to install and convenient
for maintenance.

DIE-CAST ALUMINUM BRACKET

High mechanical strength,
anti-wind resistance of Level-16.





Enlarge
LED Module

3030 LED chip

HIGH POWER

Enlarged capacity LED module design, equipped with high-brightness Bridgelux LED chips, improving the brightness by 30%.

REMOTE CONTROL

Three lighting modes for choice, flexible to switch via remote control.

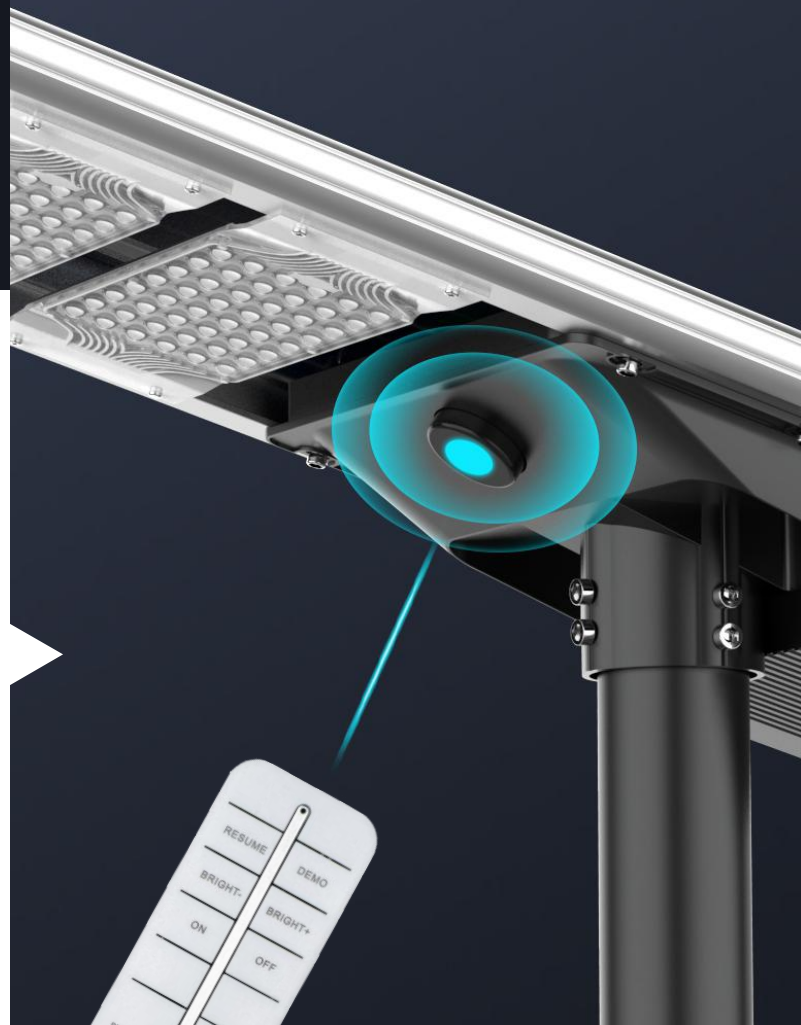

Product Advantage

02 PART TWO SPECIFICATION

Model	AN-SLZ					
Power	40W	50W	60W	80W	100W	120W
LED	96pcs	144pcs	144pcs	240pcs	336pcs	336pcs
Luminous	210 lm/w					
LiFePO4 Battery	12.8V/28AH	12.8V/36AH	12.8V/42AH	12.8V/57AH	12.8V/63AH	12.8V/72AH
Mono Solar Panel	18V/65W	18V/70W	18V/80W	18V/100W	18V/130W	18V/140W
Solar Charging Time	6-8 hours by bright sunlight					
Lighting Time In Rainy Day	7-10 days					
Lighting Mode	12hrs motion sensor control (Bright lighting 30secs when people move through the light) + Remote Controller					
PIR	120°, >8m					
Material Work	Aluminium alloy + PMMA					
IP/IK Class	IP66 / IK 10					
Temperature	-25°C to 65°C					

Full Range of Six Products

The first choice for
engineering lighting



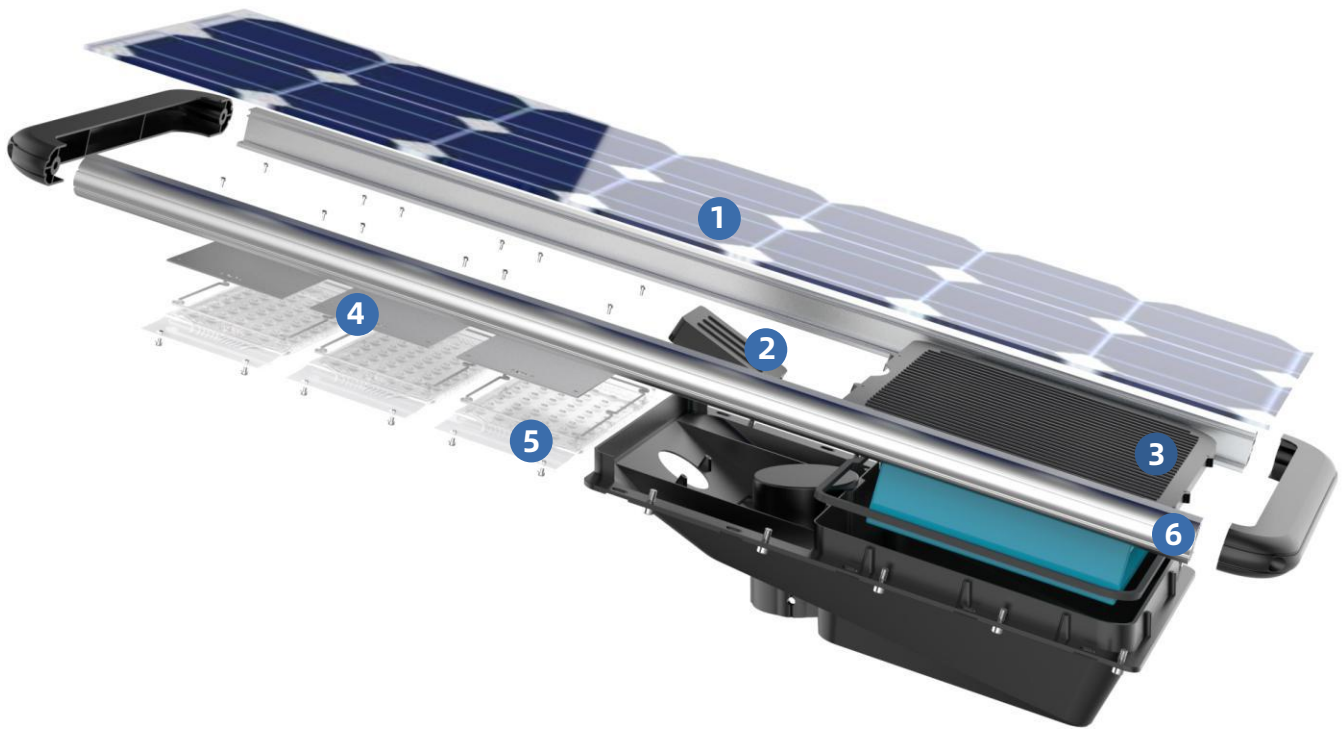

1 Mono Solar Panel

2 Control Module

3 LifePo4 Battery

4 LED Plate

5 Optical Len

6 Die-cast Aluminum Bracket

01

LifePo4 Battery

Brand new and big capacity

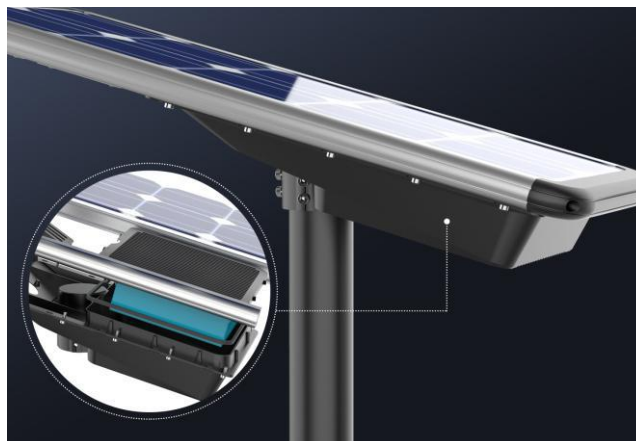

02

Mono Solar Panel

22% photoelectric conversion efficiency

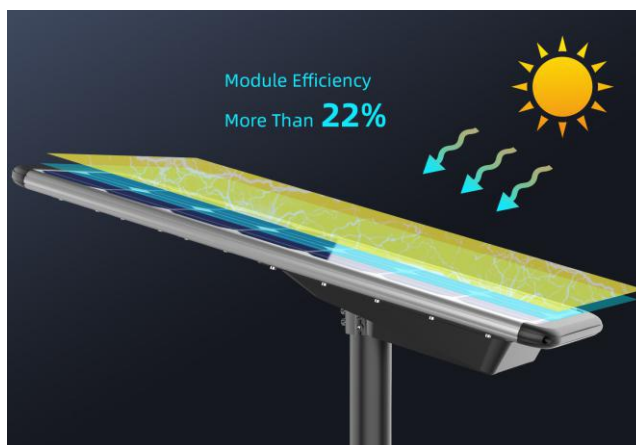

03

PIR Sensor

More than 8m sensing distance



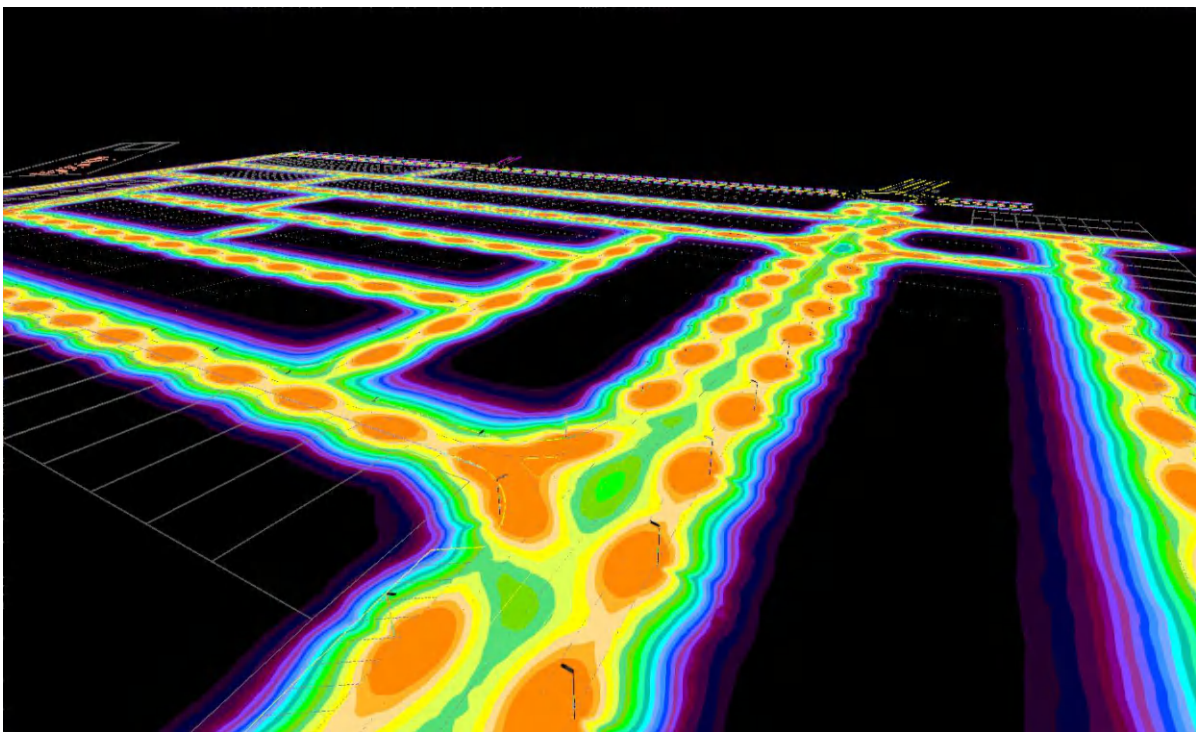
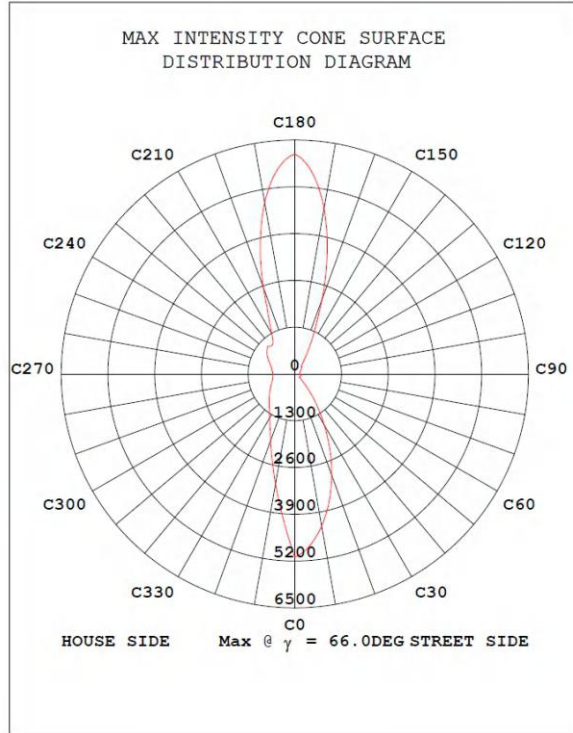
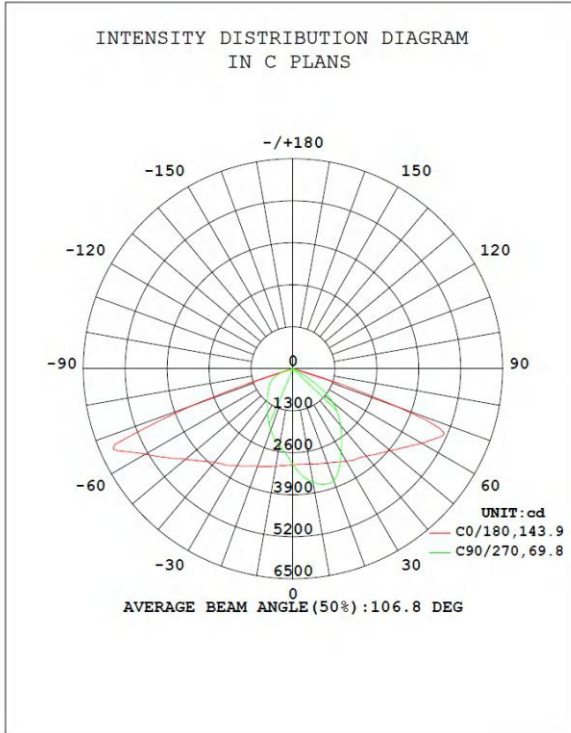

PART SIX | DIMENSION FIGURE

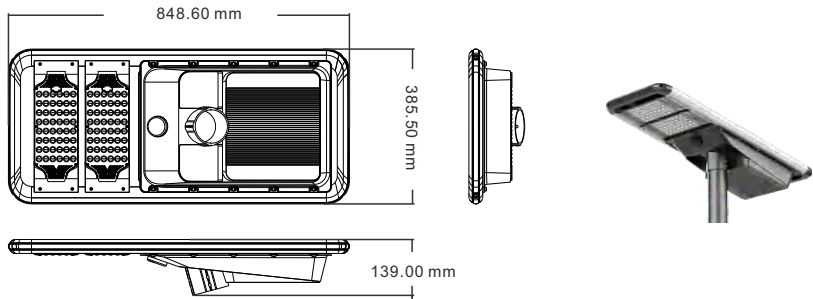
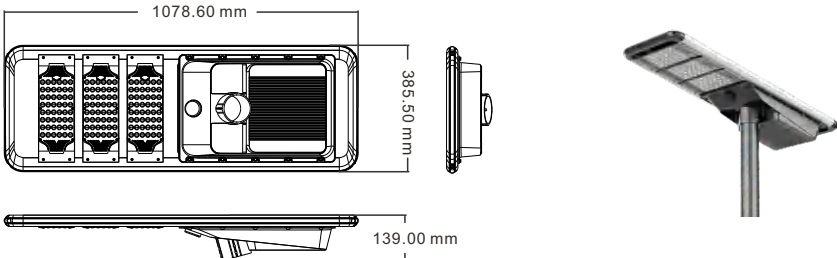
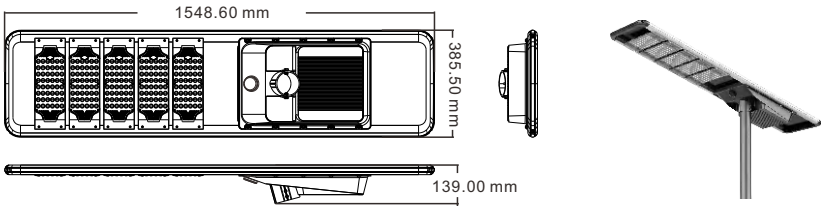
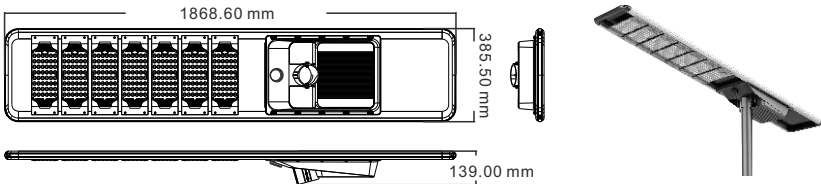
Item No.	Solar Street Light Size
<p>AN-SLZ-40W 848.60x385.50x139.00mm</p>	
<p>AN-SLZ-50W/60W 1078.60x385.50x139.00mm</p>	
<p>AN-SLZ-80W 1548.60x385.50x139.00mm</p>	
<p>AN-SLZ-100W/120W 1868.60x385.50x139.00mm</p>	

A N E R N / S T R E E T / L I G H T

Amern®

THANKS VERY MUCH